

Low Power, High Slew Rate, Wide Bandwidth, JFET Input Operational Amplifiers

Quality bipolar fabrication with innovative design concepts are employed for the MC33181/2/4, MC34181/2/4 series of monolithic operational amplifiers. This JFET input series of operational amplifiers operates at 210 μA per amplifier and offers 4.0 MHz of gain bandwidth product and 10 V/ μs slew rate. Precision matching and an innovative trim technique of the single and dual versions provide low input offset voltages. With a JFET input stage, this series exhibits high input resistance, low input offset voltage and high gain. The all NPN output stage, characterized by no deadband crossover distortion and large output voltage swing, provides high capacitance drive capability, excellent phase and gain margins, low open loop high frequency output impedance and symmetrical source/sink AC frequency response.

The MC33181/2/4, MC34181/2/4 series of devices are specified over the commercial or industrial/vehicular temperature ranges. The complete series of single, dual and quad operational amplifiers are available in the plastic DIP as well as the SOIC surface mount packages.

- Low Supply Current: 210 μA (Per Amplifier)
- Wide Supply Operating Range: $\pm 1.5\text{ V}$ to $\pm 18\text{ V}$
- Wide Bandwidth: 4.0 MHz
- High Slew Rate: 10 V/ μs
- Low Input Offset Voltage: 2.0 mV
- Large Output Voltage Swing: -14 V to $+14\text{ V}$ (with $\pm 15\text{ V}$ Supplies)
- Large Capacitance Drive Capability: 0 pF to 500 pF
- Low Total Harmonic Distortion: 0.04%
- Excellent Phase Margin: 67°
- Excellent Gain Margin: 6.7 dB
- Output Short Circuit Protection
- Offered in New TSSOP Package Including the Standard SOIC and DIP Packages

ORDERING INFORMATION

Op Amp Function	Device	Operating Temperature Range	Package
Single	MC34181P MC34181D	$T_A = 0^\circ$ to $+70^\circ\text{C}$	Plastic DIP SO-8
	MC33181P MC33181D	$T_A = -40^\circ$ to $+85^\circ\text{C}$	Plastic DIP SO-8
Dual	MC34182P MC34182D	$T_A = 0^\circ$ to $+70^\circ\text{C}$	Plastic DIP SO-8
	MC33182P MC33182D	$T_A = -40^\circ$ to $+85^\circ\text{C}$	Plastic DIP SO-8
Quad	MC34184P MC34184D MC34184DTB	$T_A = 0^\circ$ to $+70^\circ\text{C}$	Plastic DIP SO-14 TSSOP-14
	MC33184P MC33184D MC33184DTB	$T_A = -40^\circ$ to $+85^\circ\text{C}$	Plastic DIP SO-14 TSSOP-14

MC34181,2,4 MC33181,2,4

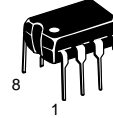

P SUFFIX
PLASTIC PACKAGE
CASE 626



D SUFFIX
PLASTIC PACKAGE
CASE 751
(SO-8)

PIN CONNECTIONS

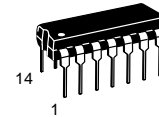
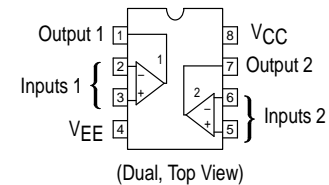
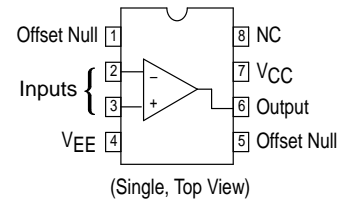

P SUFFIX
PLASTIC PACKAGE
CASE 646

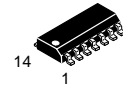

D SUFFIX
PLASTIC PACKAGE
CASE 751A
(SO-14)



DTB SUFFIX
PLASTIC PACKAGE
CASE 948G
(TSSOP-14)

PIN CONNECTIONS

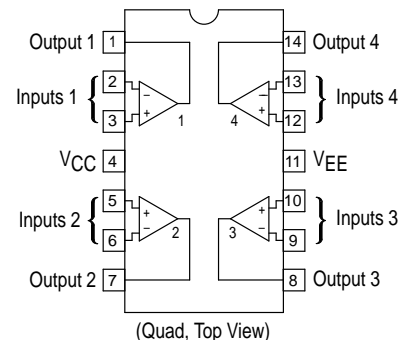

MC34181,2,4 MC33181,2,4

MAXIMUM RATINGS

Rating	Symbol	Value	Unit
Supply Voltage (from V_{CC} to V_{EE})	V_S	+36	V
Input Differential Voltage Range	V_{IDR}	Note 1	V
Input Voltage Range	V_{IR}	Note 1	V
Output Short Circuit Duration (Note 2)	t_{SC}	Indefinite	sec
Operating Junction Temperature	T_J	+150	°C
Storage Temperature Range	T_{stg}	-60 to +150	°C

NOTES: 1. Either or both input voltages should not exceed the magnitude of V_{CC} or V_{EE} .
 2. Power dissipation must be considered to ensure maximum junction temperature (T_J) is not exceeded (see Figure 1).

Representative Schematic Diagram (Each Amplifier)

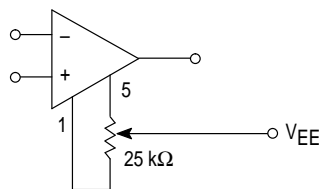
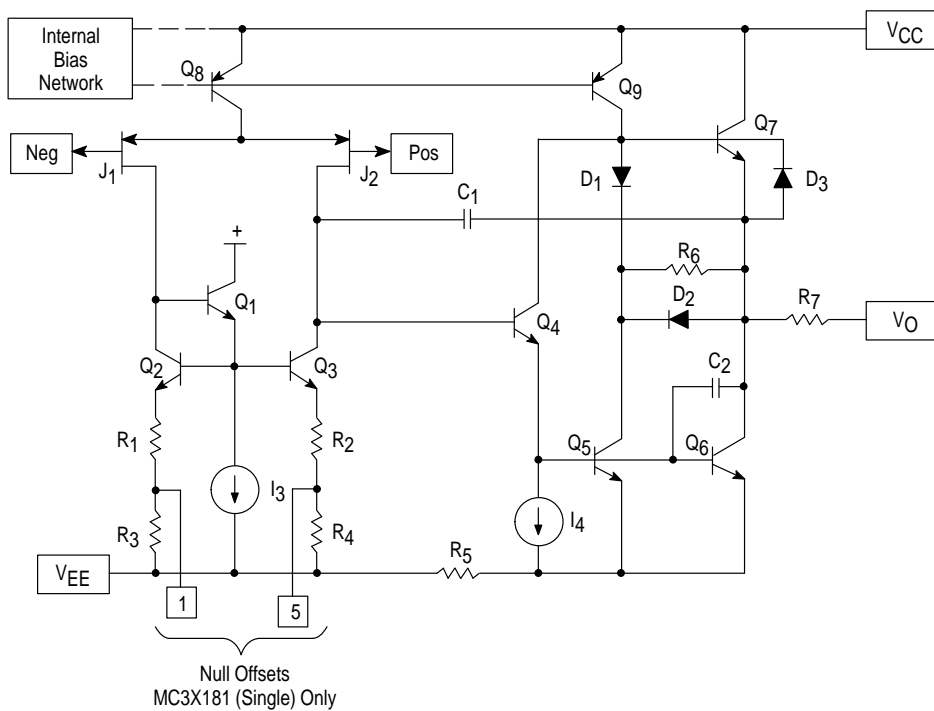

MC3X181 Input Offset
Voltage Null Circuit

MC34181,2,4 MC33181,2,4

DC ELECTRICAL CHARACTERISTICS ($V_{CC} = +15\text{ V}$, $V_{EE} = -15\text{ V}$, $T_A = 25^\circ\text{C}$, unless otherwise noted.)

Characteristics	Symbol	Min	Typ	Max	Unit
Input Offset Voltage ($R_S = 50\ \Omega$, $V_O = 0\text{ V}$) Single $T_A = +25^\circ\text{C}$ $T_A = 0^\circ\text{ to }+70^\circ\text{C}$ (MC34181) $T_A = -40^\circ\text{ to }+85^\circ\text{C}$ (MC33181) Dual $T_A = +25^\circ\text{C}$ $T_A = 0^\circ\text{ to }+70^\circ\text{C}$ (MC34182) $T_A = -40^\circ\text{ to }+85^\circ\text{C}$ (MC33182) Quad $T_A = +25^\circ\text{C}$ $T_A = 0^\circ\text{ to }+70^\circ\text{C}$ (MC34184) $T_A = -40^\circ\text{ to }+85^\circ\text{C}$ (MC33184)	V_{IO}	—	0.5	2.0	mV
Average Temperature Coefficient of V_{IO} ($R_S = 50\ \Omega$, $V_O = 0\text{ V}$)	$\Delta V_{IO}/\Delta T$	—	10	—	$\mu\text{V}/^\circ\text{C}$
Input Offset Current ($V_{CM} = 0\text{ V}$, $V_O = 0\text{ V}$) $T_A = +25^\circ\text{C}$ $T_A = 0^\circ\text{ to }+70^\circ\text{C}$ $T_A = -40^\circ\text{ to }+85^\circ\text{C}$	I_{IO}	—	0.001	0.05	nA
Input Bias Current ($V_{CM} = 0\text{ V}$, $V_O = 0\text{ V}$) $T_A = +25^\circ\text{C}$ $T_A = 0^\circ\text{ to }+70^\circ\text{C}$ $T_A = -40^\circ\text{ to }+85^\circ\text{C}$	I_{IB}	—	0.003	0.1	nA
Input Common Mode Voltage Range	V_{ICR}	$(V_{EE} + 4.0\text{ V})$ to $(V_{CC} - 2.0\text{ V})$			V
Large Signal Voltage Gain ($R_L = 10\text{ k}\Omega$, $V_O = \pm 10\text{ V}$) $T_A = +25^\circ\text{C}$ $T_A = T_{low}$ to T_{high}	A_{VOL}	25 15	60 —	— —	V/mV
Output Voltage Swing ($V_{ID} = 1.0\text{ V}$, $R_L = 10\text{ k}\Omega$) $T_A = +25^\circ\text{C}$	V_{O+} V_{O-}	+13.5 —	+14 -14	— -13.5	V
Common Mode Rejection ($R_S = 50\ \Omega$, $V_{CM} = V_{ICR}$, $V_O = 0\text{ V}$)	CMR	70	86	—	dB
Power Supply Rejection ($R_S = 50\ \Omega$, $V_{CM} = 0\text{ V}$, $V_O = 0\text{ V}$)	PSR	70	84	—	dB
Output Short Circuit Current ($V_{ID} = 1.0\text{ V}$, Output to Ground) Source Sink	I_{SC}	3.0 8.0	8.0 11	— —	mA
Power Supply Current (No Load, $V_O = 0\text{ V}$) Single $T_A = +25^\circ\text{C}$ $T_A = T_{low}$ to T_{high} Dual $T_A = +25^\circ\text{C}$ $T_A = T_{low}$ to T_{high} Quad $T_A = +25^\circ\text{C}$ $T_A = T_{low}$ to T_{high}	I_D	— — — — —	210 — 420 — 840	250 250 500 500 1000	μA

MC34181,2,4 MC33181,2,4

AC ELECTRICAL CHARACTERISTICS ($V_{CC} = +15\text{ V}$, $V_{EE} = -15\text{ V}$, $T_A = 25^\circ\text{C}$, unless otherwise noted.)

Characteristics	Symbol	Min	Typ	Max	Unit
Slew Rate ($V_{in} = -10\text{ V to } +10\text{ V}$, $R_L = 10\text{ k}\Omega$, $C_L = 100\text{ pF}$) $A_V = +1.0$ $A_V = -1.0$	SR	7.0 —	10 10	— —	V/ μs
Settling Time ($A_V = -1.0$, $R_L = 10\text{ k}\Omega$, $V_O = 0\text{ V to } +10\text{ V Step}$) To Within 0.10% To Within 0.01%	t_s	— —	1.1 1.5	— —	μs
Gain Bandwidth Product ($f = 100\text{ kHz}$)	GBW	3.0	4.0	—	MHz
Power Bandwidth ($A_V = +1.0$, $R_L = 10\text{ k}\Omega$, $V_O = 20\text{ V}_{pp}$, THD = 5.0%)	BW _p	—	120	—	kHz
Phase Margin ($-10\text{ V} < V_O < +10\text{ V}$) $R_L = 10\text{ k}\Omega$ $R_L = 10\text{ k}\Omega$, $C_L = 100\text{ pF}$	f_m	— —	67 34	— —	Degrees
Gain Margin ($-10\text{ V} < V_O < +10\text{ V}$) $R_L = 10\text{ k}\Omega$ $R_L = 10\text{ k}\Omega$, $C_L = 100\text{ pF}$	A_m	— —	6.7 3.4	— —	dB
Equivalent Input Noise Voltage $R_S = 100\ \Omega$, $f = 1.0\text{ kHz}$	e_n	—	38	—	nV/ $\sqrt{\text{Hz}}$
Equivalent Input Noise Current $f = 1.0\text{ kHz}$	i_n	—	0.01	—	pA/ $\sqrt{\text{Hz}}$
Differential Input Capacitance	C_i	—	3.0	—	pF
Differential Input Resistance	R_i	—	10^{12}	—	Ω
Total Harmonic Distortion $A_V = 10$, $R_L = 10\text{ k}\Omega$, $2.0\text{ V}_{pp} < V_O < 20\text{ V}_{pp}$, $f = 1.0\text{ kHz}$	THD	—	0.04	—	%
Channel Separation ($R_L = 10\text{ k}\Omega$, $-10\text{ V} < V_O < +10\text{ V}$, $0\text{ Hz} < f < 10\text{ kHz}$)	—	—	120	—	dB
Open Loop Output Impedance ($f = 1.0\text{ MHz}$)	$ Z_o $	—	200	—	Ω

Figure 1. Maximum Power Dissipation versus Temperature for Package Variations

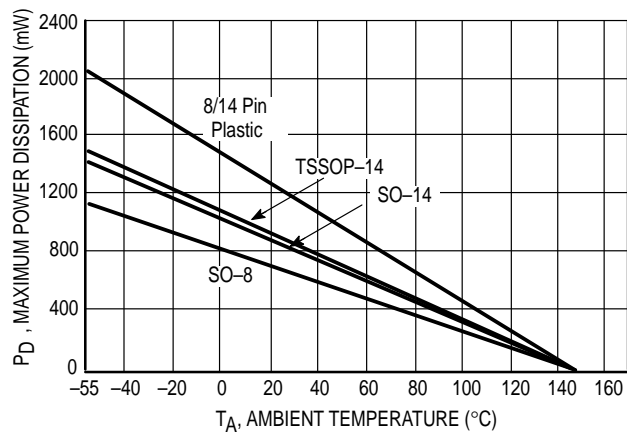

Figure 2. Input Common Mode Voltage Range versus Temperature

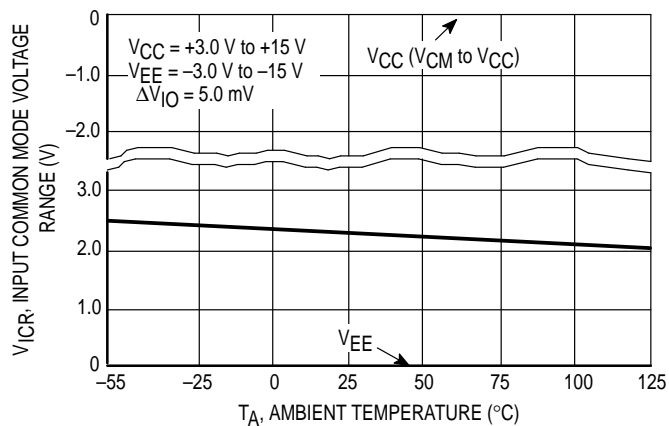

Figure 3. Input Bias Current versus Temperature

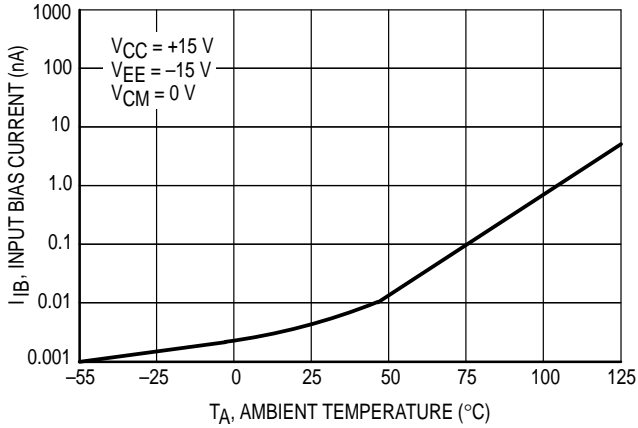

Figure 4. Input Bias Current versus Input Common Mode Voltage

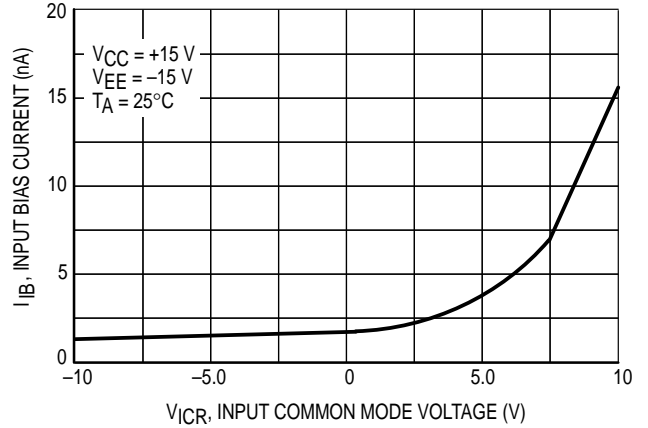

Figure 5. Output Voltage Swing versus Supply Voltage

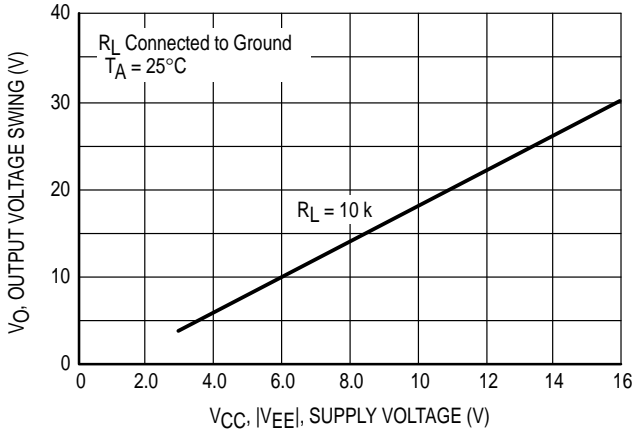

Figure 6. Output Saturation Voltage versus Load Current

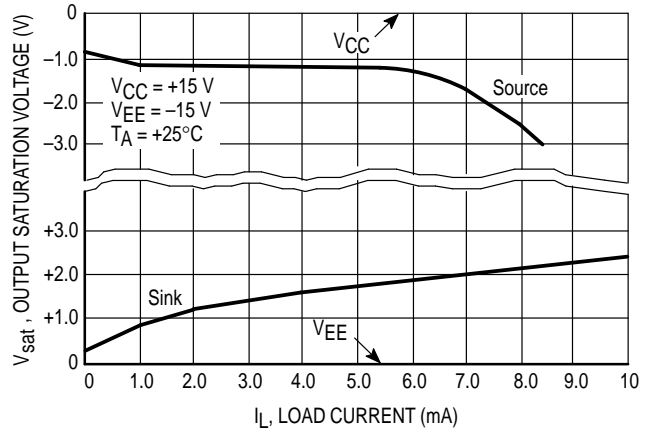

Figure 7. Output Saturation Voltage versus Load Resistance to Ground

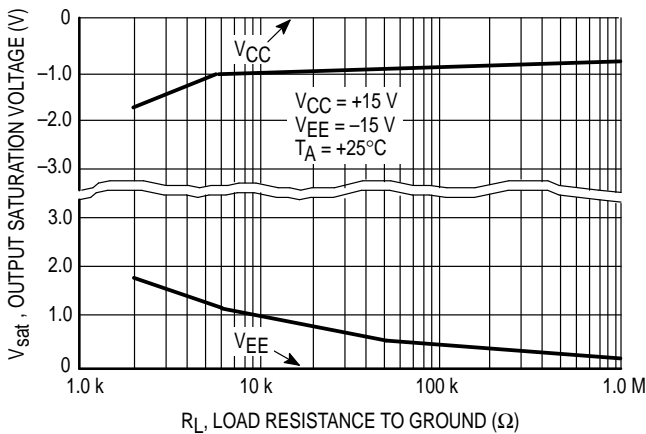

Figure 8. Output Saturation Voltage versus Load Resistance to V_{CC}

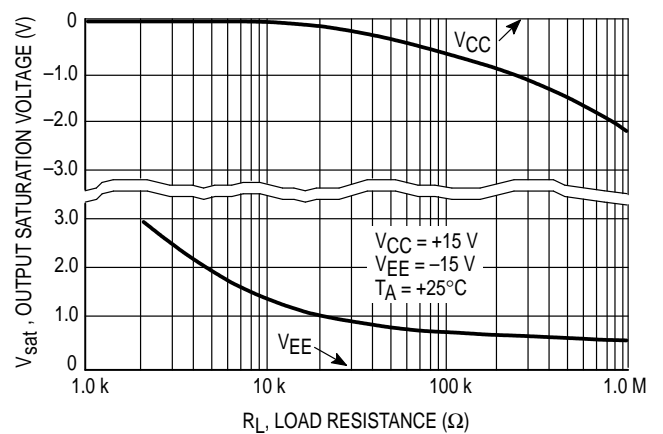

Figure 9. Output Short Circuit Current versus Temperature

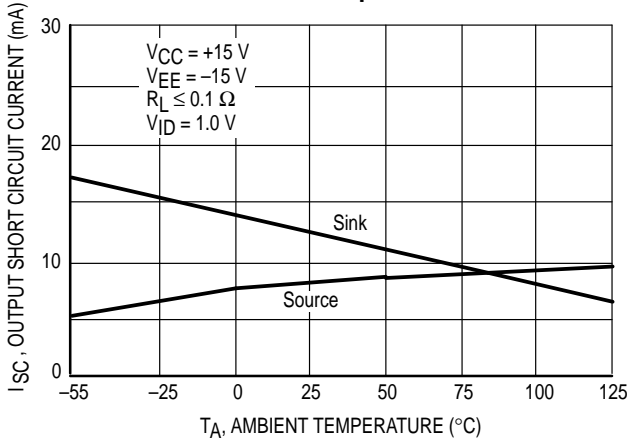

Figure 10. Output Impedance versus Frequency

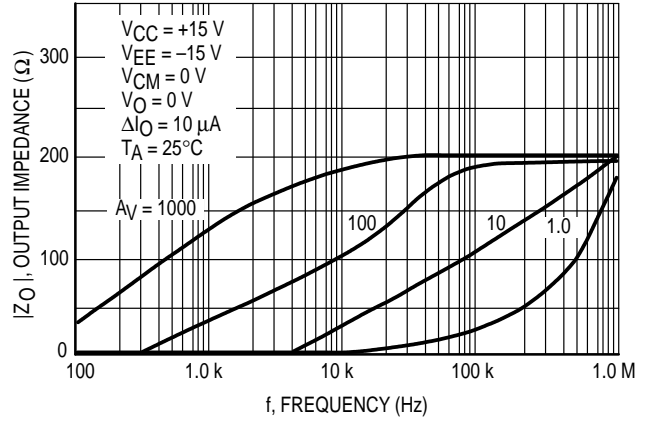

Figure 11. Output Voltage Swing versus Frequency

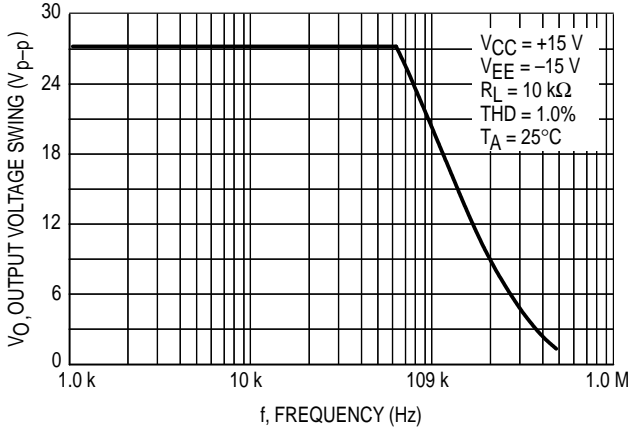

Figure 12. Output Distortion versus Frequency

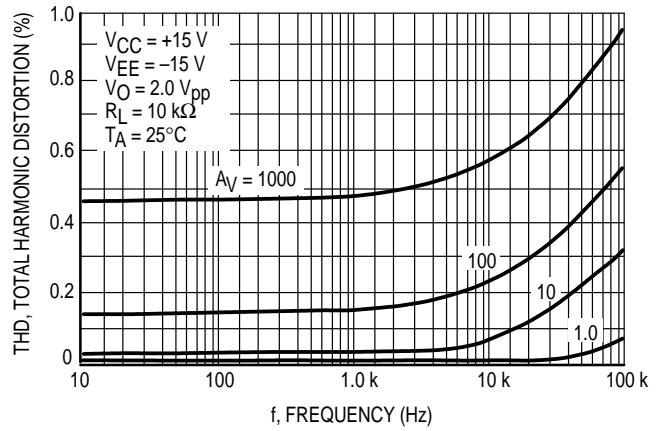

Figure 13. Open Loop Voltage Gain versus Temperature

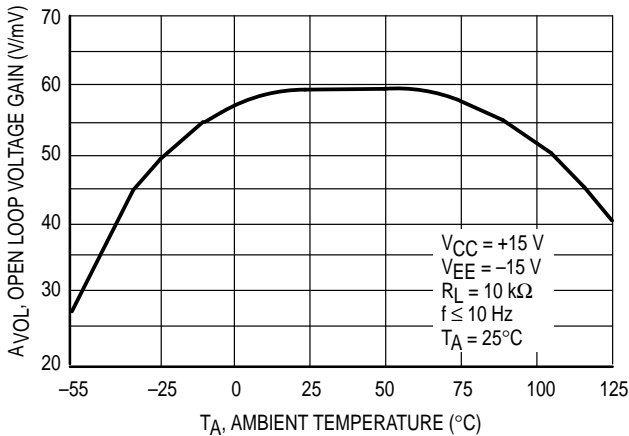

Figure 14. Open Loop Voltage Gain and Phase versus Frequency

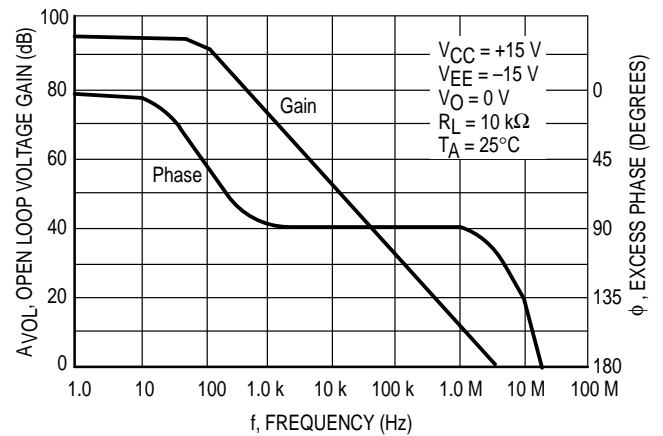

Figure 15. Normalized Gain Bandwidth Product versus Temperature

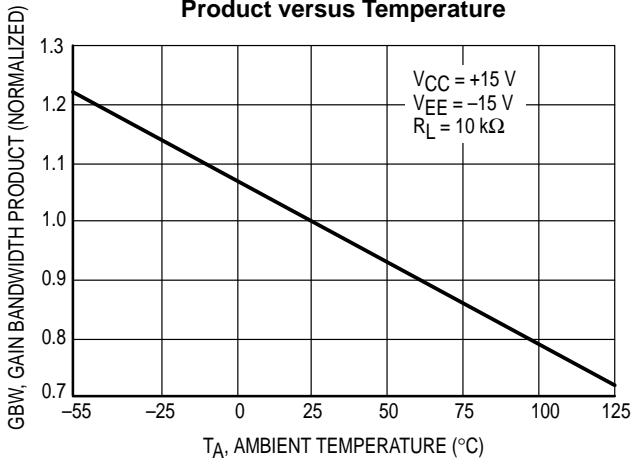

Figure 16. Output Voltage Overshoot versus Load Capacitance

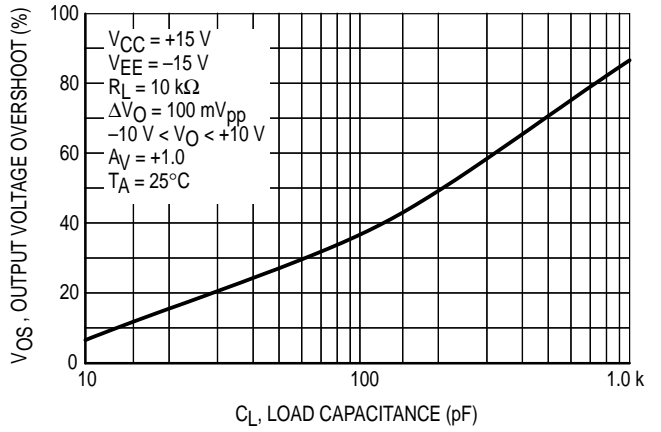

Figure 17. Phase Margin versus Load Capacitance

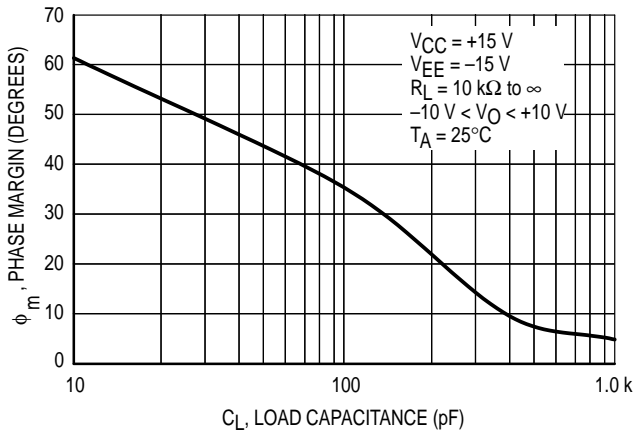

Figure 18. Gain Margin versus Load Capacitance

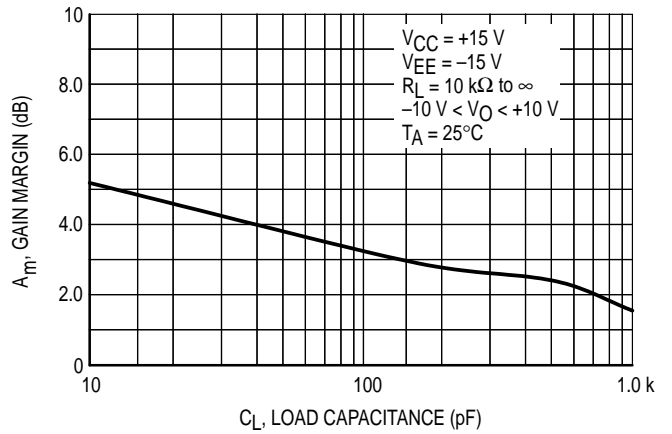

Figure 19. Phase Margin versus Temperature

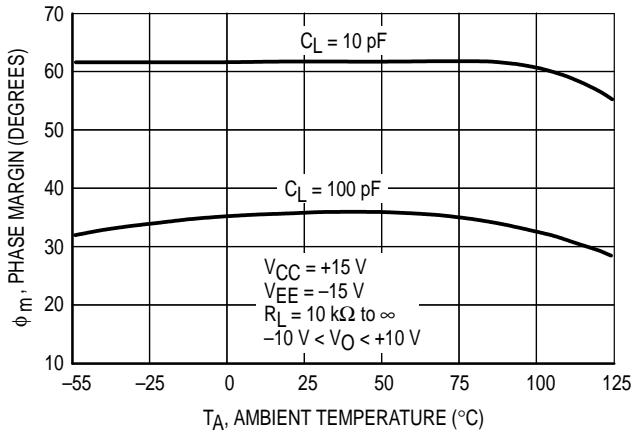

Figure 20. Gain Margin versus Temperature

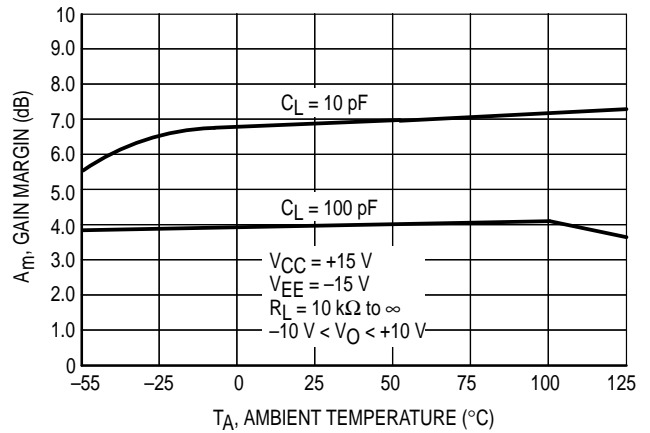

Figure 21. Normalized Slew Rate versus Temperature

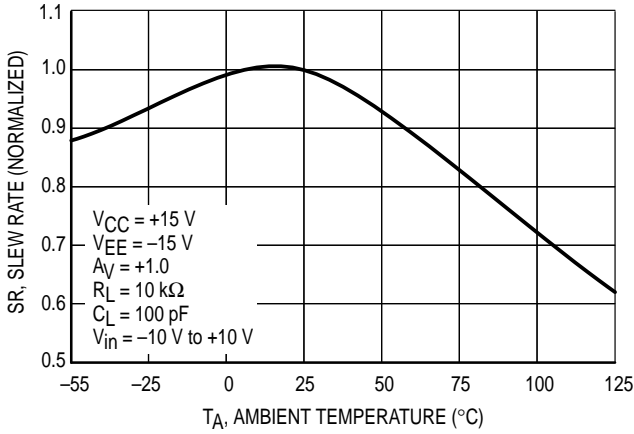

Figure 22. Common Mode Rejection versus Frequency

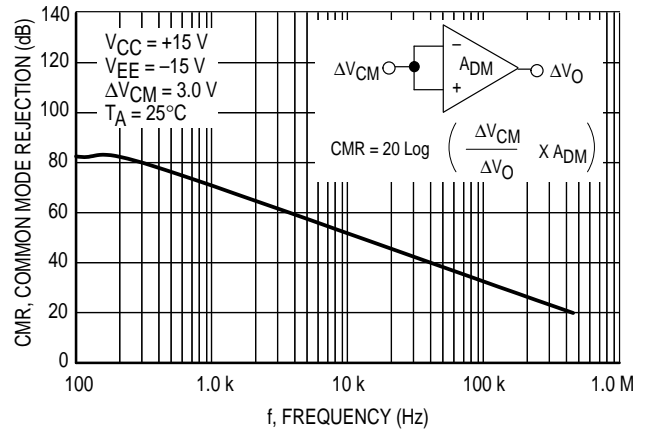

Figure 23. Input Noise Voltage versus Frequency

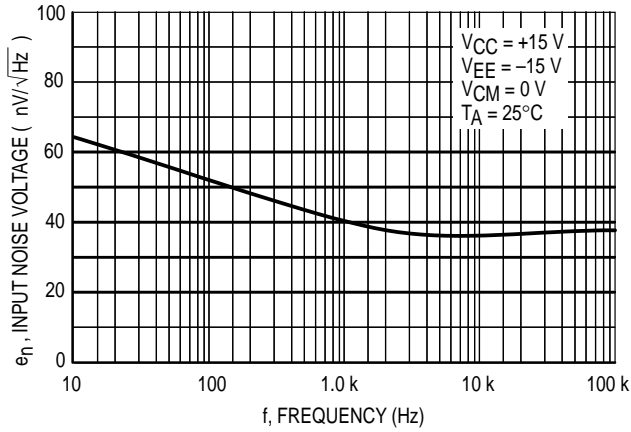

Figure 24. Power Supply Rejection versus Temperature

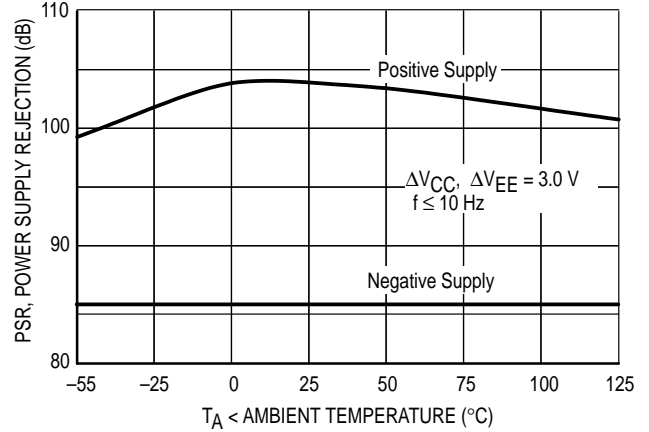

Figure 25. Power Supply Rejection versus Frequency

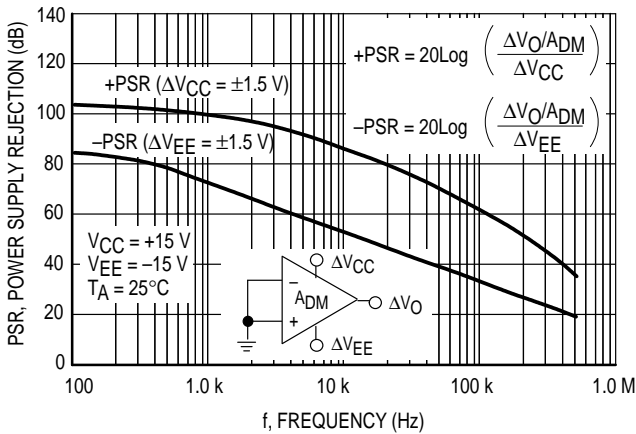

Figure 26. Normalized Supply Current versus Supply Voltage

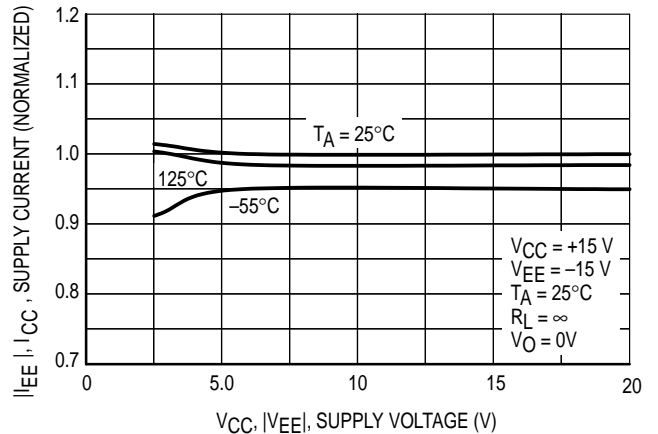

Figure 27. Channel Separation versus Frequency

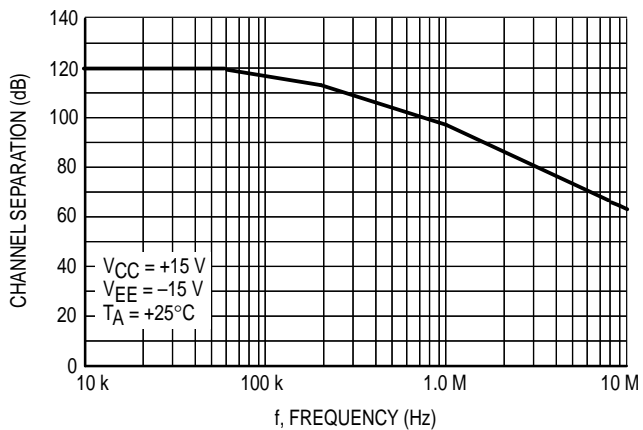

Figure 28. Transient Response

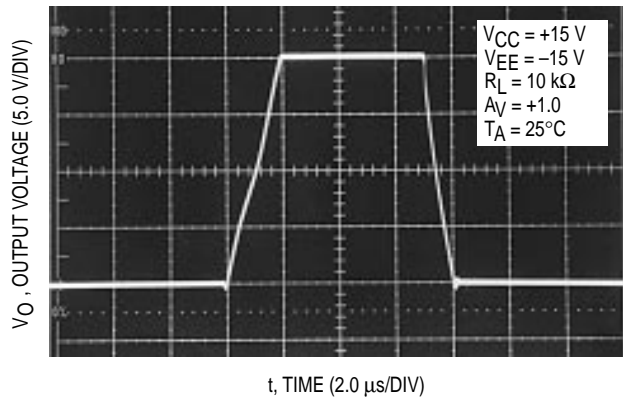
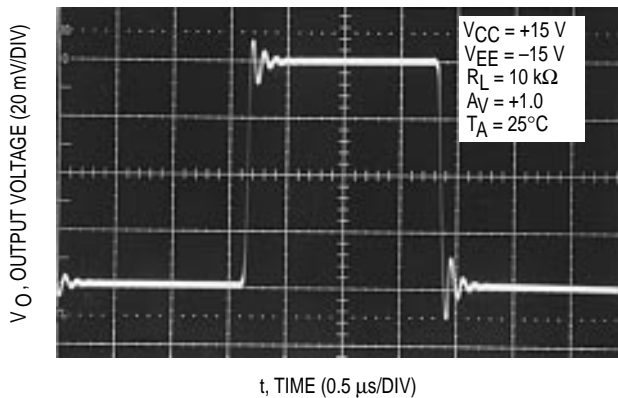
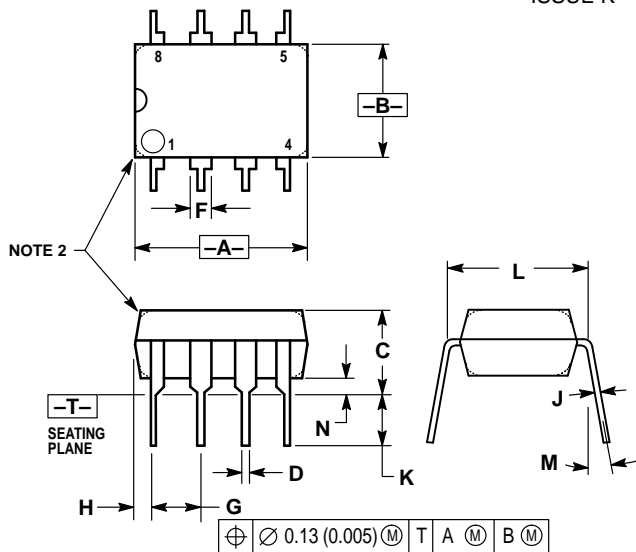

Figure 29. Small Signal Transient Reponse



OUTLINE DIMENSIONS

P SUFFIX
 PLASTIC PACKAGE
 CASE 626-05
 ISSUE K



- NOTES:
1. DIMENSION L TO CENTER OF LEAD WHEN FORMED PARALLEL.
 2. PACKAGE CONTOUR OPTIONAL (ROUND OR SQUARE CORNERS).
 3. DIMENSIONING AND TOLERANCING PER ANSI Y14.5M, 1982.

DIM	MILLIMETERS		INCHES	
	MIN	MAX	MIN	MAX
A	9.40	10.16	0.370	0.400
B	6.10	6.60	0.240	0.260
C	3.94	4.45	0.155	0.175
D	0.38	0.51	0.015	0.020
F	1.02	1.78	0.040	0.070
G	2.54 BSC		0.100 BSC	
H	0.76	1.27	0.030	0.050
J	0.20	0.30	0.008	0.012
K	2.92	3.43	0.115	0.135
L	7.62 BSC		0.300 BSC	
M	—		10°	
N	0.76	1.01	0.030	0.040

D SUFFIX
 PLASTIC PACKAGE
 CASE 751-05
 (SO-8)
 ISSUE R

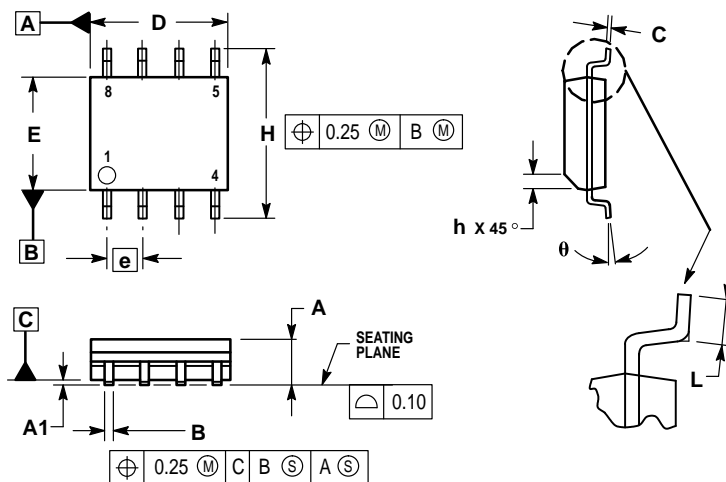

- NOTES:
1. DIMENSIONING AND TOLERANCING PER ASME Y14.5M, 1994.
 2. DIMENSIONS ARE IN MILLIMETERS.
 3. DIMENSION D AND E DO NOT INCLUDE MOLD PROTRUSION.
 4. MAXIMUM MOLD PROTRUSION 0.15 PER SIDE.
 5. DIMENSION B DOES NOT INCLUDE MOLD PROTRUSION. ALLOWABLE DAMBAR PROTRUSION SHALL BE 0.127 TOTAL IN EXCESS OF THE B DIMENSION AT MAXIMUM MATERIAL CONDITION.

DIM	MILLIMETERS	
	MIN	MAX
A	1.35	1.75
A1	0.10	0.25
B	0.35	0.49
C	0.18	0.25
D	4.80	5.00
E	3.80	4.00
e	1.27 BSC	
H	5.80	6.20
h	0.25	0.50
L	0.40	1.25
θ	0°	
	7°	

MC34181,2,4 MC33181,2,4

OUTLINE DIMENSIONS – continued

P SUFFIX PLASTIC PACKAGE CASE 646-06 ISSUE L

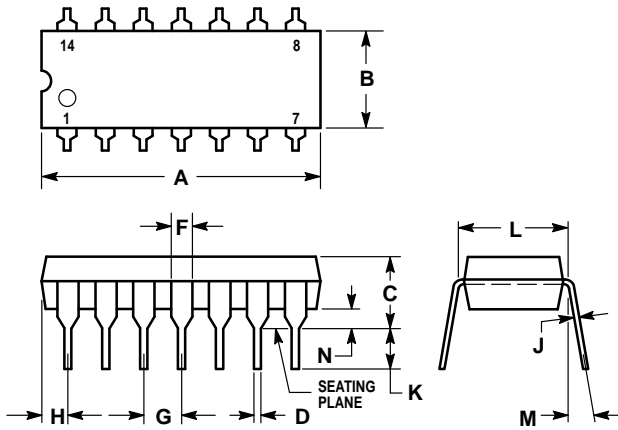

NOTES:

- LEADS WITHIN 0.13 (0.005) RADIUS OF TRUE POSITION AT SEATING PLANE AT MAXIMUM MATERIAL CONDITION.
- DIMENSION L TO CENTER OF LEADS WHEN FORMED PARALLEL.
- DIMENSION B DOES NOT INCLUDE MOLD FLASH.
- ROUNDED CORNERS OPTIONAL.

DIM	INCHES		MILLIMETERS	
	MIN	MAX	MIN	MAX
A	0.715	0.770	18.16	19.56
B	0.240	0.260	6.10	6.60
C	0.145	0.185	3.69	4.69
D	0.015	0.021	0.38	0.53
F	0.040	0.070	1.02	1.78
G	0.100 BSC		2.54 BSC	
H	0.052	0.095	1.32	2.41
J	0.008	0.015	0.20	0.38
K	0.115	0.135	2.92	3.43
L	0.300 BSC		7.62 BSC	
M	0°	10°	0°	10°
N	0.015	0.039	0.39	1.01

D SUFFIX PLASTIC PACKAGE CASE 751A-03 (SO-14) ISSUE F

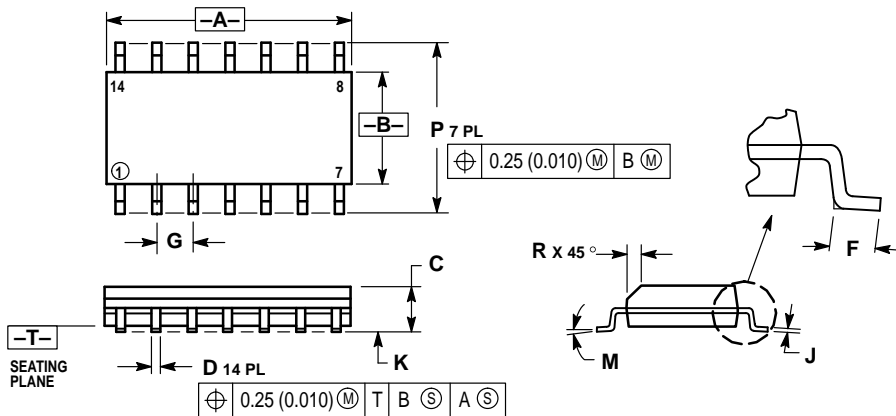

NOTES:

- DIMENSIONING AND TOLERANCING PER ANSI Y14.5M, 1982.
- CONTROLLING DIMENSION: MILLIMETER.
- DIMENSIONS A AND B DO NOT INCLUDE MOLD PROTRUSION.
- MAXIMUM MOLD PROTRUSION 0.15 (0.006) PER SIDE.
- DIMENSION D DOES NOT INCLUDE DAMBAR PROTRUSION. ALLOWABLE DAMBAR PROTRUSION SHALL BE 0.127 (0.005) TOTAL IN EXCESS OF THE D DIMENSION AT MAXIMUM MATERIAL CONDITION.

DIM	MILLIMETERS		INCHES	
	MIN	MAX	MIN	MAX
A	8.55	8.75	0.337	0.344
B	3.80	4.00	0.150	0.157
C	1.35	1.75	0.054	0.068
D	0.35	0.49	0.014	0.019
F	0.40	1.25	0.016	0.049
G	1.27 BSC		0.050 BSC	
J	0.19	0.25	0.008	0.009
K	0.10	0.25	0.004	0.009
M	0°	7°	0°	7°
P	5.80	6.20	0.228	0.244
R	0.25	0.50	0.010	0.019

MC34181,2,4 MC33181,2,4

Motorola reserves the right to make changes without further notice to any products herein. Motorola makes no warranty, representation or guarantee regarding the suitability of its products for any particular purpose, nor does Motorola assume any liability arising out of the application or use of any product or circuit, and specifically disclaims any and all liability, including without limitation consequential or incidental damages. "Typical" parameters which may be provided in Motorola data sheets and/or specifications can and do vary in different applications and actual performance may vary over time. All operating parameters, including "Typicals" must be validated for each customer application by customer's technical experts. Motorola does not convey any license under its patent rights nor the rights of others. Motorola products are not designed, intended, or authorized for use as components in systems intended for surgical implant into the body, or other applications intended to support or sustain life, or for any other application in which the failure of the Motorola product could create a situation where personal injury or death may occur. Should Buyer purchase or use Motorola products for any such unintended or unauthorized application, Buyer shall indemnify and hold Motorola and its officers, employees, subsidiaries, affiliates, and distributors harmless against all claims, costs, damages, and expenses, and reasonable attorney fees arising out of, directly or indirectly, any claim of personal injury or death associated with such unintended or unauthorized use, even if such claim alleges that Motorola was negligent regarding the design or manufacture of the part. Motorola and  are registered trademarks of Motorola, Inc. Motorola, Inc. is an Equal Opportunity/Affirmative Action Employer.

How to reach us:

USA/EUROPE/Locations Not Listed: Motorola Literature Distribution;
P.O. Box 20912; Phoenix, Arizona 85036. 1-800-441-2447 or 602-303-5454

JAPAN: Nippon Motorola Ltd.; Tatsumi-SPD-JLDC, 6F Seibu-Butsuryu-Center,
3-14-2 Tatsumi Koto-Ku, Tokyo 135, Japan. 03-81-3521-8315

MFAX: RMFAX0@email.sps.mot.com – TOUCHTONE 602-244-6609
INTERNET: <http://Design-NET.com>

ASIA/PACIFIC: Motorola Semiconductors H.K. Ltd.; 8B Tai Ping Industrial Park,
51 Ting Kok Road, Tai Po, N.T., Hong Kong. 852-26629298



MOTOROLA



MC34181/D



This datasheet has been download from:

www.datasheetcatalog.com

Datasheets for electronics components.